



DATA PROJECTOR

MODEL

XD90U

User Manual

XD90U

This User Manual is important to you.
Please read it before using your projector.

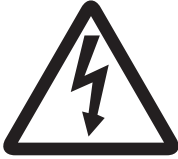

CAUTION

RISK OF ELECTRIC SHOCK
DO NOT OPEN



**CAUTION : TO REDUCE THE RISK OF ELECTRIC SHOCK,
DO NOT REMOVE COVER (OR BACK)
NO USER-SERVICEABLE PARTS INSIDE
REFER SERVICING TO QUALIFIED
SERVICE PERSONNEL.**



The lightning flash with arrowhead symbol within an equilateral triangle is intended to alert the user to the presence of uninsulated "dangerous voltage" within the product's enclosure that may be of sufficient magnitude to constitute a risk of electric shock.



The exclamation point within an equilateral triangle is intended to alert the user to the presence of important operating and maintenance (servicing) instructions in the literature accompanying the appliance.

WARNING:

TO PREVENT FIRE OR SHOCK HAZARD, DO NOT EXPOSE THIS APPLIANCE TO RAIN OR MOISTURE.

CAUTION:

TO PREVENT ELECTRIC SHOCK, DO NOT USE THIS (POLARIZED) PLUG WITH AN EXTENSION CORD, RECEPTACLE OR OTHER OUTLET UNLESS THE BLADES CAN BE FULLY INSERTED TO PREVENT BLADE EXPOSURE.

NOTE:

SINCE THIS PROJECTOR IS PLUGGABLE EQUIPMENT, THE SOCKET-OUTLET SHALL BE INSTALLED NEAR THE EQUIPMENT AND SHALL BE EASILY ACCESSIBLE.

WARNING

Use the attached specified power supply cord. If you use another power supply cord, it may cause interference with radio and television reception.

Use the attached RGB cable with this equipment so as to keep interference within the limit of an FCC Class B device.

This apparatus must be grounded.

DO NOT LOOK DIRECTLY INTO THE LENS WHEN THE PROJECTOR IS IN THE POWER ON MODE.

CAUTION

Not for use in a computer room as defined in the Standard for the Protection of Electronic Computer/ Data Processing Equipment, ANSI/NFPA 75.

The attached power cord is to be used exclusively for this product. Never use it for other products.

When using the projector in Europe:**COMPLIANCE NOTICE**

This Projector complies with the requirements of the EC Directive 89/336/EEC "EMC Directive" as amended by Directive 92/31/EEC and 93/68/EEC, and 2006/95/EC "Low Voltage Directive".

The electro-magnetic susceptibility has been chosen at a level that gains proper operation in residential areas, on business and light industrial premises and on small-scale enterprises, inside as well as outside of the buildings. All places of operation are characterized by their connection to the public low voltage power supply system.

WARNING

Use the attached RGB cable with this equipment so as to keep interference within the limits of an EN55022 Class B device.

Please follow WARNING instructions.



Note: This symbol mark is for EU countries only. This symbol mark is according to the directive 2002/96/EC Article 10 Information for users and Annex IV.

Your MITSUBISHI ELECTRIC product is designed and manufactured with high quality materials and components which can be recycled and reused.

This symbol means that electrical and electronic equipment, at their end-of-life, should be disposed of separately from your household waste.

Please, dispose of this equipment at your local community waste collection/recycling centre.

In the European Union there are separate collection systems for used electrical and electronic product.

Please, help us to conserve the environment we live in!

WARNING

- The lens cap is for protecting the lens. If you leave the lens cap on the lens with the projector turned on, it may be deformed because of heat build-up. Remove the lens cap when you turn on the projector.
- One of power cords for the U.S., Europe and U.K. is provided appropriately.
- This projector uses the power plug of three-pin grounding type. Do not remove the grounding pin from the power plug. If the power plug doesn't fit your wall outlet, ask an electrician to change the wall outlet.
- In case that the power cord for the U.S. is provided with this projector, never connect this cord to any outlet or power supply using other voltages or frequencies than rated. If you want to use a power supply using other voltage than rated, prepare an appropriate power cord separately.
- Use 100-240 V AC 50/60 Hz to prevent fire or electric shock.
- Do not place any objects on the power cord or do not place the projector near heat sources to prevent damage to the power cord. If the power cord should be damaged, contact your dealer for replacement because it may cause fire or electric shock.
- Do not modify or alter the power cord. If the power cord is modified or altered, it may cause fire or electric shock.

Contents

Important Safeguards	5
Overview	8
Remote Control	11
Installation	13
Basic Connection	17
Basic Operation	22
Menu Operation	29
Maintenance	38
Replacing the Lamp	40
Indicators	42
Troubleshooting	44
Specifications	46

Declaration of Conformity

Model Number : XD90U
Trade Name : MITSUBISHI ELECTRIC
Responsible party : Mitsubishi Digital Electronics America, Inc.
9351 Jeronimo Road, Irvine, CA 92618 U.S.A
Telephone number : +1-(949) 465-6000

This device complies with Part 15 of the FCC Rules. Operation is subject to the following two conditions:

- (1) this device may not cause harmful interference, and
- (2) this device must accept any interference received, including interference that may cause undesired operation.

Trademark, Registered trademark

Macintosh is registered trademark of Apple Computer Inc.

DLP™, Digital Micromirror Device and DMD are all trademarks of Texas Instruments.

Other brand or product names are trademarks or registered trademarks of their respective holders.

Important Safeguards

Please read all these instructions regarding your projector and retain them for future reference. Follow all warnings and instructions marked on the projector.

1. Read instructions
All the safety and operating instructions should be read before the appliance is operated.
2. Retain instructions
The safety and operating instructions should be retained for future reference.
3. Warnings
All warnings on the appliance and in the operating instructions should be adhered to.
4. Instructions
All operating instructions must be followed.
5. Cleaning
Unplug this projector from the wall outlet before cleaning it. Do not use liquid aerosol cleaners. Use a damp soft cloth for cleaning.
6. Attachments and equipment
Never add any attachments and/or equipment without the approval of the manufacturer as such additions may result in the risk of fire, electric shock or other personal injury.
7. Water and moisture
Do not use this projector near water or in contact with water.
8. Accessories
Do not place this projector on an unstable cart, stand, tripod, bracket or table. Use only with a cart, stand, tripod bracket, or table recommended by the manufacturer or sold with the projector. Any mounting of the appliance should follow the manufacturer's instructions and should use a mounting accessory recommended by the manufacturer.



An appliance and cart combination should be moved with care. Quick stops, excessive force and uneven surfaces may cause the appliance and cart combination to overturn.

9. Ventilation
Slots and openings in the cabinet are provided for ventilation, ensuring reliable operation of the projector and to protect it from overheating. Do

not block these openings or allow them to be blocked by placing the projector on a bed, sofa, rug, or bookcase. Ensure that there is adequate ventilation and that the manufacturer's instructions have been adhered to.

10. Power sources
This projector should be operated only from the type of power source indicated on the marking label. If you are not sure of the type of power, please consult your appliance dealer or local power company.
11. Power-cord protection
Power-supply cords should be routed so that they are not likely to be walked on or pinched by items placed upon or against them. Pay particular attention to cords at plugs, convenience receptacles, and points where they exit from the appliance. Do not put the power cord under a carpet.
12. Overloading
Do not overload wall outlets and extension cords as this can result in a fire or electric shock.
13. Objects and liquids
Never push objects of any kind through openings of this projector as they may touch dangerous voltage points or short-out parts that could result in a fire or electric shock. Never spill liquid of any kind on the projector.
14. Servicing
Do not attempt to service this projector yourself. Refer all servicing to qualified service personnel.
15. Damage requiring service
Unplug this projector from the wall outlet and refer servicing to qualified service personnel under the following conditions:
 - (a) If the power-supply cord or plug is damaged.
 - (b) If liquid has been spilled, or objects have fallen into the projector.
 - (c) If the projector does not operate normally after you follow the operating instructions. Adjust only those controls that are covered by the operating instructions. An improper adjustment of other controls may result in damage and may often require extensive work by a qualified technician to restore the projector to its normal operation.
 - (d) If the projector has been exposed to rain or water.
 - (e) If the projector has been dropped or the cabinet has been damaged.

- (f) If the projector exhibits a distinct change in performance - this indicates a need for service.

16. Replacement parts

When replacement parts are required, be sure that the service technician has used replacement parts specified by the manufacturer or parts having the same characteristics as the original part. Unauthorized substitutions may result in fire, electric shock or other hazards.

17. Safety check

Upon completion of any service or repair to this projector, ask the service technician to perform safety checks determining that the projector is in a safe operating condition.

WARNING:

Unplug immediately if there is something wrong with your projector.

Do not operate if smoke, strange noise or odor comes out of your projector. It may cause fire or electric shock. In this case, unplug immediately and contact your dealer.

Never remove the cabinet.

This projector contains high voltage circuitry. An inadvertent contact may result in an electric shock. Except as specifically explained in User Manual, do not attempt to service this product by yourself. Please contact your dealer when you want to fix, adjust, or inspect the projector.

Do not modify the projector.

It can lead to fire or electric shock.

Do not keep using the damaged projector.

If the projector is dropped and the cabinet is damaged, unplug the projector and contact your dealer for inspection. It may lead to fire if you keep using the damaged projector.

Do not face the projection lens to the sun.

It can lead to fire.

Use correct voltage.

If you use incorrect voltage, it can lead to fire.

Do not place the projector on uneven surface.

Place the projector on a level and stable surface only.

Do not look into the lens when the projector is operating.

It may hurt your eyes. Never let children look into the lens when the projector is on.

Do not unplug the power cord during operation.

It can lead to lamp breakage, fire, electric shock or other trouble. Wait for the fan to stop before unplugging the power cord. Do not touch the air outlet grilles and bottom plate.

Do not touch them or put other equipment close to the air outlet grilles because they become hot during operation. The heated air outlet grilles and bottom plate may cause injury or damage to other equipment. Also, do not put the projector on a desk that is easily affected by heat.

Do not look into the air outlet grilles when projector is operating.

Heat, dust, etc. may blow out of them and hurt your eyes.

Do not block the air inlet and outlet grilles.

If they are blocked, heat may be generated inside the projector, causing deterioration in the projector quality and fire.

Do not use flammable solvents (benzene, thinner, etc.) and flammable aerosols near the projector.

Flammable substances may ignite causing fire or breakdown because the temperature inside the projector rises very high while the lamp is illuminating.

Place of installation

For safety's sake, do not use the projector at any place subjected to high temperature and high humidity. Please maintain an operating temperature, humidity, and altitude as specified below.

- Operating temperature: between +41°F (+5°C) and +95°F (+35°C)
- Operating humidity: between 30% and 90%
- Never put any heat-producing device under the projector to prevent the projector from being overheated.
- Do not install the projector at a place that is unstable or subject to vibration.
- Do not install the projector near any equipment that produces a strong magnetic field. Also refrain from installing the projector near any cable carrying a large amount of current.
- Place the projector on a solid, vibration-free surface. Otherwise it may fall, causing serious injury or damage.
- Do not stand the projector on its end. It may fall, causing serious injury or damage.
- Slanting the projector more than $\pm 10^\circ$ (right and left) or $\pm 15^\circ$ (front and rear) may cause trouble or explosion of the lamp.
- Do not place the projector near air-conditioning unit or heater to avoid the air outlet and inlet grilles from being exposed to hot air.

COMPLIANCE NOTICE OF FCC

This equipment has been tested and found to comply with the limits for a Class B digital device, pursuant to Part 15 of the FCC Rules. These limits are designed to provide reasonable protection against harmful interference in a residential installation. This equipment generates, uses and can radiate radio frequency energy and, if not installed and used in accordance with the instructions, may cause harmful interference to radio communications. However, there is no guarantee that interference will not occur in a particular installation. If this equipment does cause harmful interference to radio or television reception, which can be determined by turning the equipment off and on, the user is encouraged to try to correct the interference by one or more of the following measures:

- Reorient or relocate the receiving antenna.
- Increase the separation between the equipment and receiver.
- Connect the equipment into an outlet on a circuit different from that to which the receiver is connected.
- Consult the dealer or an experienced Radio / TV technician for help.

Changes or modifications not expressly approved by Mitsubishi could void the user's authority to operate this equipment.

COMPLIANCE NOTICE OF INDUSTRY CANADA

This Class B digital apparatus complies with Canadian ICES-003.

Overview

Front / Upper side

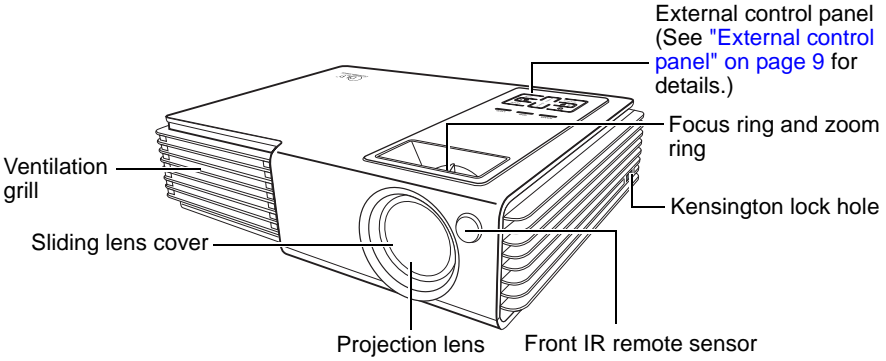

Rear side

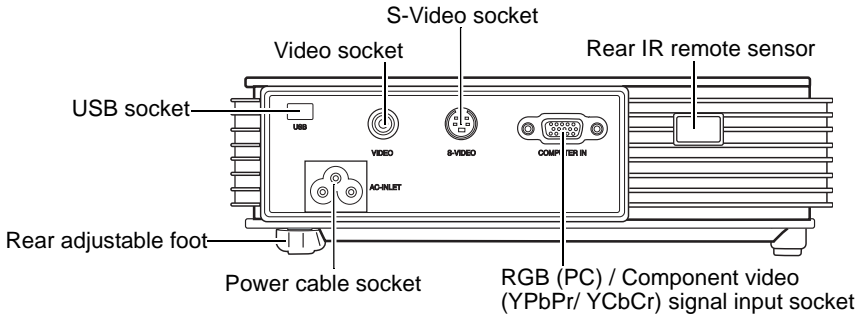

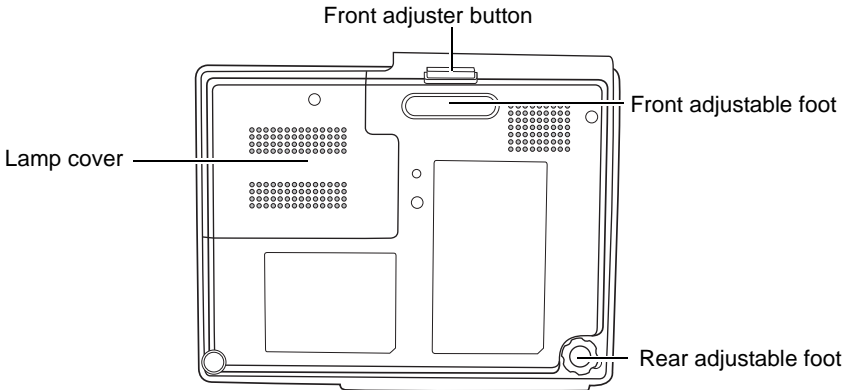

Lower side

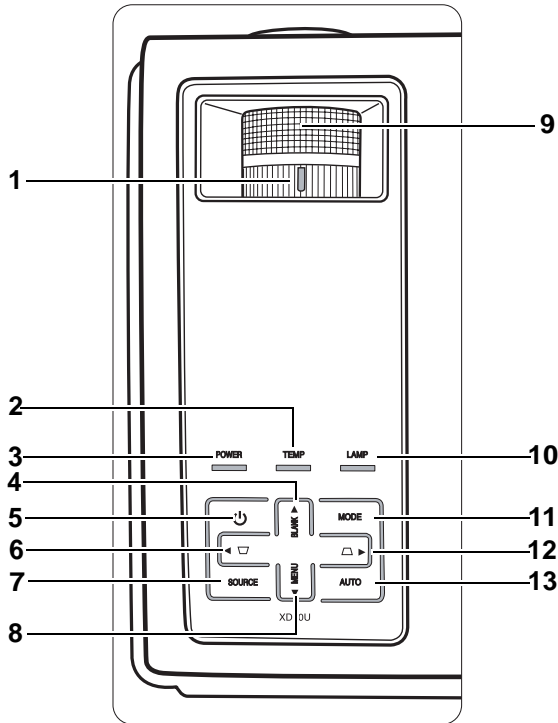

External control panel



1. **Zoom ring (Refer to "Fine-tuning the image size and clarity" on page 25 for more information)**
Adjusts the size of the projected image. Rotate clockwise to enlarge the image or rotate counter-clockwise to reduce the image size.
2. **TEMPerature warning light (Refer to "Illustration" on page 42 for more information)**
Flashes red if the projector's temperature becomes too high.
3. **POWER indicator light (Refer to "Illustration" on page 42 for more information)**
Lights up or flashes when the projector is under operation.
4. **BLANK/^ Up button (Refer to "Hiding the image" on page 27 and "Using the menus" on page 30 for more information)**
Press this button to hide the screen image. You can press this button again to bring the image back.
When the on-screen menu is activated, press this button to move the selection focus up.
5. **Power button (Refer to "Start up" on page 22 and "Shutdown" on page 28 for more information)**
Turns the projector on or off.
When the projector is in standby, press once to turn the projector on.

-
- When the projector is on, press twice to switch the projector to standby.
6. **Keystone  /  Left button (Refer to "Correcting keystone" on page 25 and "Using the menus" on page 30 for more information)**



Press this button to correct keystone at the top of the projected image.
When the on-screen menu is activated, press this button to move the selection focus left or make adjustments.
 7. **SOURCE button (Refer to "Switching input signal" on page 27 for more information)**

Switches sequentially through input sources. (RGB/YPbPr, Video or S-Video).
 8. **MENU /  Down button (Refer to "Using the menus" on page 30 for more information)**

Turns on the On-Screen Display (OSD) menu.
When the on-screen menu is activated, press this button to move the selection focus down.
 9. **Focus ring (Refer to "Fine-tuning the image size and clarity" on page 25 for more information)**

Adjusts the focus of the projected image.
 10. **LAMP indicator light (Refer to "Illustration" on page 42 for more information)**

Lights up or flashes when the projector lamp has developed a problem.
 11. **MODE button (Refer to "Selecting an application mode" on page 26 for more information)**

Selects one of the application modes.
 12. **Keystone  /  Right button (Refer to "Correcting keystone" on page 25 and "Using the menus" on page 30 for more information)**

Press this button to correct keystone at the bottom of the projected image.
When the on-screen menu is activated, press this button to move the selection focus right or make adjustments.
 13. **AUTO button (Refer to "Auto-adjusting the image" on page 25 for more information)**

Press this button to let the projector automatically determine the best picture timings for the projected image.

Remote control description

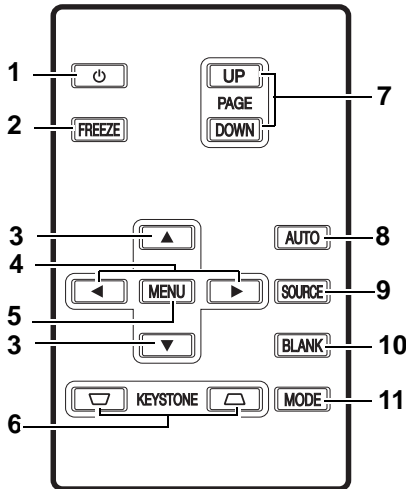

- 1. Power button (Refer to "Start up" on page 22 and "Shutdown" on page 28 for more information)**

Turns the projector on or off.

When the projector is in standby, press once to turn the projector on.

When the projector is on, press twice to switch the projector to standby.
- 2. Freeze button**

The image is frozen when **Freeze** is pressed. An icon "■" will display in the lower right corner of the screen. To release the function, press **Freeze** again or the **Source** button.
- 3. ^ Up, ▾ Down buttons (Refer to "Remote paging operations" on page 27 for more information.)**
- 4. ◀ Left, ▶ Right buttons**

When the on-screen menu is activated, the Up/Down/Left/Right buttons are used as directional arrows to select the desired menu items and to make adjustments.
- 5. MENU button (Refer to "Using the menus" on page 30 for more information.)**

Turns on the On-Screen Display (OSD) menu.
- 6. ▽ Keystone ◁ buttons (Refer to "Correcting keystone" on page 25 for more information.)**

Manually corrects distorted images resulting from an angled projection.
- 7. Page Up and Down buttons**

You can operate your display software program (on a connected PC) which responds to page up/down commands (like Microsoft PowerPoint) by pressing these buttons.
- 8. AUTO button (Refer to "Auto-adjusting the image" on page 25 for more information.)**

Automatically determines the best picture settings for the displayed image.
- 9. SOURCE button (Refer to "Switching input signal" on page 27 for more information)**

Sequentially selects input sources. (RGB/YPbPr-> Video-> S-Video)

10. BLANK button (Refer to "Switching input signal" on page 27 for more information.)

Used to hide the screen image. Press **Blank** again to restore the image.

11. MODE button (Refer to "Application Mode" on page 31 for more information.)

Depending upon which input signal is selected, there are several picture setup options available.

Remote control effective range

Infra-Red (IR) remote control sensors are located on the front and the back of the projector. The remote control must be held at an angle within 30 degrees of the projector's IR remote control sensors to function correctly. The distance between the remote control and the sensors should not exceed 6 meters (~ 20 feet).

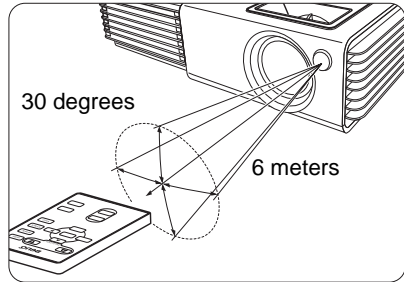

 **Make sure that there are no obstacles between the remote control and the IR sensors on the projector that might obstruct the infra-red beam.**

Installing or replacing the remote control battery

1. Pull out the battery holder.
2. Insert the new battery in the holder.
Note that the positive polarity should face outward.
3. Push the holder into the remote control.

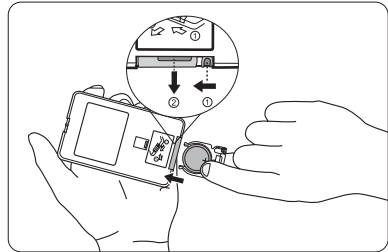

 **Avoid excessive heat and humidity.**

- There may be danger of damage to the remote and injury to those nearby if the battery is incorrectly replaced.
- Replace only with the same or equivalent type recommended by the manufacturer.
- Dispose of the used battery according to your local regulations.
- Never throw a battery into a fire. There may be danger of an explosion.
- If the battery is dead or if you will not be using the remote control for a long time, remove the battery to prevent damage to the remote control from possible battery leakage.

Choosing a location

Your projector is designed to be installed in one of two possible installation locations:

1. Floor in front of screen; or
2. Floor at rear of screen

Your room layout or personal preference will dictate which installation location you select. Take into consideration the size and position of your screen, the location of a suitable power outlet, as well as the location and distance between the projector and the rest of your equipment.

I. Floor front: Select this location with the projector placed near the floor in front of the screen. This is the most common way to position the projector for quick setup and portability.

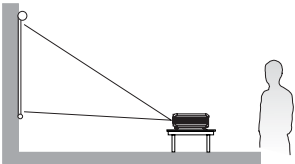

II. Floor rear: Select this location with the projector placed near the floor behind the screen.

Note that a special rear projection screen is required. Set  in the **Advance > Mirror** menu after you turn the projector on.

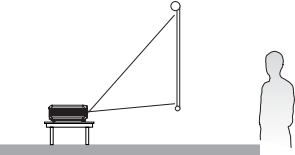

Obtaining a preferred projected image size

The distance from the projector lens to the screen, the zoom setting, and the video format each factors in the projected image size.

The maximum (native) resolution of the projector is 1024 x 768 pixels, which is a 4 to 3 aspect ratio (expressed as 4:3). To be able to project a complete 16:9 (widescreen) aspect ratio image, the projector can resize and scale a widescreen image to the projector's native aspect width. This will result in a proportionally smaller height equivalent to 75% of the projector's native aspect height.

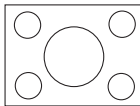

4:3 aspect image in a 4:3 aspect display area

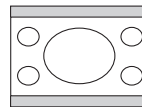

16:9 aspect image scaled to a 4:3 aspect display area

Thus, a 16:9 aspect image will not utilize 25% of the height of a 4:3 aspect image displayed by this projector. This will be seen as darkened (unlit) bars along the top and bottom (vertical 12.5% height respectively) of the 4:3 projection display area whenever displaying a scaled 16:9 aspect image in the vertical centre of the 4:3 projection display area.

When determining the position of your projector, you should consider its intended use and input signal aspect ratios. All inputs (other than composite Video being fed a 16:9 aspect signal) will display in a 4:3 aspect ratio (and will require an additional 33% display height than that of the scaled 16:9 aspect image projection area).

 **IMPORTANT:** Do not select a permanent projector position based upon a 16:9 projection if you will ever need to select an input other than composite Video being fed a 16:9 aspect signal.

The projector should always be placed horizontally level (like flat on a table), and positioned directly perpendicular (90° right-angle square) to the horizontal centre of the screen. This prevents image distortion caused by angled projections (or projecting onto angled surfaces).

The modern digital projector does not project directly forward (like older style reel-to-reel film projectors did). Instead, digital projectors are designed to project at a slightly upward angle above the horizontal plane of the projector. This is so that they can be readily placed on a table and will project forward and upwards onto a screen positioned so that the bottom edge of the screen is above the level of the table (and everyone in the room can see the screen).

You can see from the diagram on page 16, that this type of projection causes the bottom edge of the projected image to be vertically offset from the horizontal plane of the projector. If the projector is positioned further away from the screen, the projected image size increases, and the vertical offset also increases proportionately.

When determining the position of the screen and projector, you will need to account for both the projected image size and the vertical offset dimension, which are directly proportional to the projection distance.

XD90U has provided a table of 4:3-aspect-ratio screen sizes (see "[Screen size chart](#)" on [page 16](#)) to assist you in determining the ideal location for your projector. There are two dimensions to consider, the perpendicular horizontal distance from the centre of the screen (projection distance), and the vertical offset height of the projector from the horizontal edge of the screen (offset).

How to determine the position of the projector for a given screen size

1. Select your screen size.
2. Refer to the table on [page 16](#) and find the closest match to your screen size in the left columns labelled '4:3 Screen Diagonal' and '4:3 Aspect in mm'. Using this value, look across this row to the right to find the corresponding average distance from screen value in the column labelled 'Average'. This is the projection distance.
3. On that same row, look across to the right column and make note of the vertical Offset value. This will determine the final vertical offset placement of the projector in relation to the edge of the screen.
4. The recommended position for the projector is aligned perpendicular to the horizontal centre of the screen, at the distance from the screen determined in step 2 above, and offset by the value determined in step 3 above.

For example, if you are using a 120-inch screen, the average projection distance is 4757 mm and with a vertical offset of 229 mm.

If you place the projector in a different position (to that recommended), you will have to tilt it down or up to center the image on the screen. In these situations, some image distortion will occur. Use the Keystone function to correct the distortion. See "[Correcting keystone](#)" on [page 25](#) for keystone correction.

How to determine the recommended screen size for a given distance

This method can be used for situations where you have purchased this projector and would like to know what screen size will fit in your room. The maximum screen size is limited by the physical space available in your room.

1. Measure the distance between the projector and where you want to position the screen. This is the projection distance.
2. Refer to the table on page 16 and find the closest match to your measurement in the average distance from screen column labelled 'Average'. Check that your measured distance is between the min and max distances listed on either side of the average distance value.
3. Using this value, look across that row to the left to find the corresponding screen diameter listed in that row. That is the projected image size of the projector at that projection distance.
4. On that same row, look across to the right column and make note of the vertical Offset value. This will determine the final placement of the screen in relation to the horizontal plane of the projector.

For example, if your measured projection distance was 4.5m (4500mm), the closest match in the Average column is 4682mm. Looking across this row shows that a 3000mm (3m) screen is required. If you can only obtain imperial sized screens, the listed screen sizes on either side of the 3m screen are the 9' and 10' screens.

Checking the min and max projection distance values for the these (9' & 10') sizes, indicates that the 4.5m measured projection distance will fit these screens too. The projector can be adjusted (using the zoom control) to display on these different screen sizes at that projection distance. Be aware that these different screens have different vertical offset values.

Screen size chart

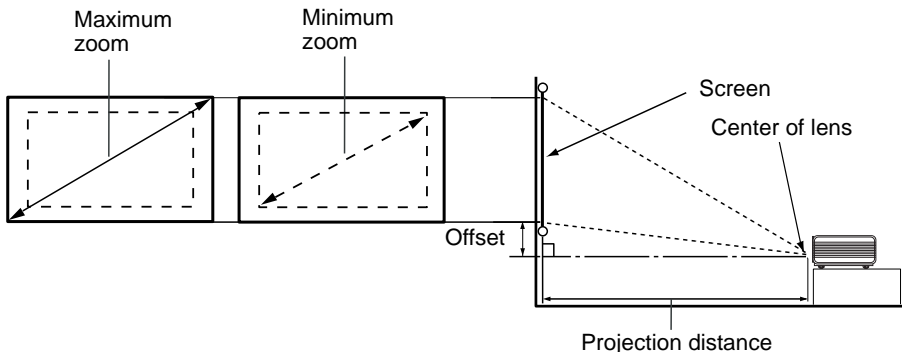

4:3 Screen Diagonal			4:3 Aspect in mm		Distance from Screen in mm			Vertical Offset in mm
Feet	Inches	mm	Width	Height	Min length (with max. zoom)	Average	Max length (with min. zoom)	
4	48	1219	975	732	1752	1903	2054	91
		1500	1200	900	2155	2341	2527	113
5	60	1524	1219	914	2190	2379	2568	114
		1829	1463	1097	2628	2854	3081	137
6	72	2000	1600	1200	2874	3122	3370	150
		2134	1707	1280	3066	3330	3595	160
8	96	2438	1951	1463	3503	3806	4109	183
		2500	2000	1500	3592	3902	4212	188
9	108	2743	2195	1646	3941	4282	4622	206
		3000	2400	1800	4310	4682	5054	225
10	120	3048	2438	1829	4379	4757	5135	229
		3500	2800	2100	5029	5463	5897	263
12	144	3658	2926	2195	5256	5709	6163	274
		4000	3200	2400	5747	6243	6739	300
15	180	4572	3658	2743	6569	7136	7703	343
		5000	4000	3000	7184	7804	8424	375
18	216	5486	4389	3292	7883	8563	9244	411
		6000	4800	3600	8621	9365	10109	450
25	300	7620	6096	4572	10948	11893	12838	572

 There is 3% ~ 5% tolerance among these numbers due to optical component variations.

Basic Connection

When connecting a signal source to the projector, be sure to:

- Turn all equipment off before making any connections.
- Use the correct signal cables for each source.
- Ensure the cables are firmly inserted.



In the connections shown below, some cables may not be included with the projector (see "What's included in the box" on page 47). They are commercially available from electronics stores.

This projector has no speaker or built-in support for audio reproduction.

Connecting a computer

The projector provides a VGA input socket that allows you to connect it to a notebook or desktop computer.

Additionally, you can also connect the projector to a computer via the USB cable so you can perform paging operations of the application on the PC or notebook. (see "Remote paging operations" on page 27).

To connect the projector to a notebook or desktop computer:

1. Take the supplied RGB cable and connect one end to the D-Sub output socket of the computer.
2. Connect the other end of the RGB cable to the D-SUB/COMP IN signal input socket on the projector.
3. If you wish to use the remote paging function (see "Remote paging operations" on page 27), take the supplied USB cable and connect the larger end to the USB port of the computer, and the smaller end to the USB socket on the projector.

The final connection path should be like that shown in the following diagram:

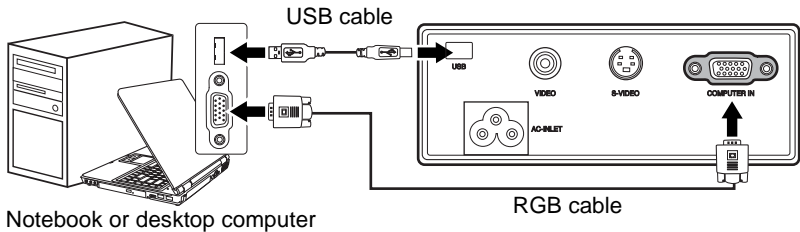

A Mac adapter (an optional accessory) is needed if you are connecting legacy version (<http://www.info.apple.com/usen/legacy/>) Macintosh computers.

Many notebook computers do not turn on their external video ports when connected to a projector. Usually a key combo like FN + F3 or CRT/LCD key turns the external display on/off. Locate a function key labeled CRT/LCD or a function key with a monitor symbol on the notebook computer. Press FN and the labeled function key simultaneously. Refer to your notebook computer's documentation to find your notebook computer's key combination.

Connecting Video source devices

This section describes how to connect the projector to Video source devices using video cables. Video cable connections are recommended for Video presentations.

You can connect your projector to various Video source devices that provide any one of the following output sockets:

- Component Video
- S-Video
- Video (composite)

You need only connect the projector to a Video source device using just one of the above connecting methods, however each provides a different level of video quality. The method you choose will most likely depend upon the availability of matching terminals on both the projector and the Video source device as described below:

Best video quality

The best available video connection method is Component Video (not to be confused with composite Video). Digital TV tuner and DVD players output Component Video natively, so if available on your devices, this should be your connection method of choice in preference to (composite) Video.

See ["Connecting a Component Video source device" on page 19](#) for how to connect the projector to a component video device.

Better video quality

The S-Video method provides a better quality analog video than standard composite Video. If you have both composite Video and S-Video output terminals on your Video source device, you should elect to use the S-Video option.

See ["Connecting an S-Video source device" on page 20](#) for how to connect the projector to an S-Video device.

Least video quality

Composite Video is an analog video and will result in a perfectly acceptable, but less than optimal result from your projector, being the least video quality of the available methods described here.

See ["Connecting a composite Video source device" on page 21](#) for how to connect the projector to a composite Video device.

Connecting a Component Video source device

Examine your Video source device to determine if it has a set of unused Component Video output sockets available:

- If so, you can continue with this procedure.
- If not, you will need to reassess which method you can use to connect to the device.

To connect the projector to a Component Video source device

1. Take the (optional accessory) Component Video to VGA (D-Sub) adaptor cable and connect the end with 3 RCA type connectors to the Component Video output sockets of the Video source device. Match the color of the plugs to the color of the sockets; green to green, blue to blue, and red to red.
2. Connect the other end of the Component Video to VGA (D-Sub) adaptor cable (with a D-Sub type connector) to the D-SUB/COMP IN socket on the projector.

The final connection path should be like that shown in the following diagram:

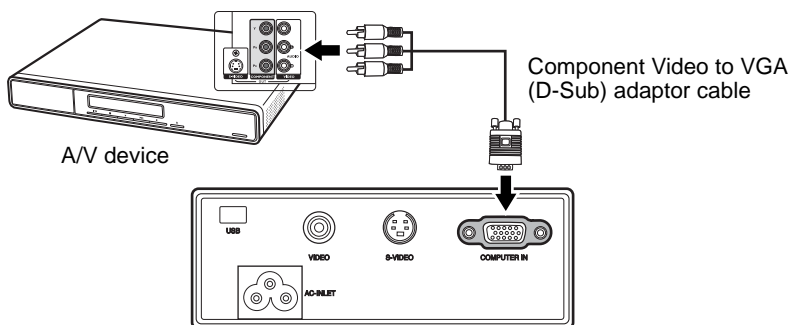

Component Video is the only video output that delivers native 16:9 aspect ratio picture.

If you connect the projector to a High Definition TV (HDTV) tuner, the following standards are supported:

- | | |
|--------------------|---------------------|
| • 480i | • 480p |
| • 576i | • 576p |
| • 720p (50/ 60 Hz) | • 1080i (50/ 60 Hz) |

If the selected video image is not displayed after the projector is turned on and the correct video source has been selected, check that the Video source device is turned on and operating correctly. Also check that the signal cables have been connected correctly.

Connecting an S-Video source device

Examine your Video source device to determine if it has an unused S-Video output socket available:

- If so, you can continue with this procedure.
- If not, you will need to reassess which method you can use to connect to the device.

To connect the projector to an S-Video source device

1. Take an appropriate S-Video cable (not supplied) and connect one end to the S-Video output socket of the Video source device.
2. Connect the other end of the S-Video cable to the S-VIDEO socket on the projector.

The final connection path should be like that shown in the following diagram:

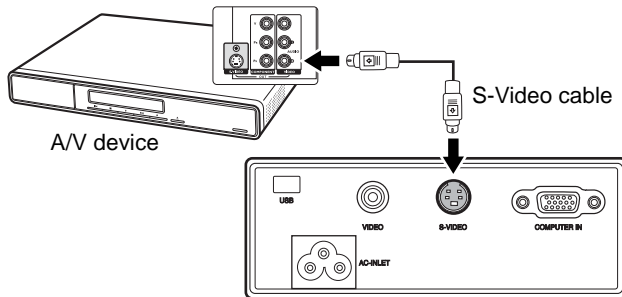

- ☞ • If the selected video image is not displayed after the projector is turned on and the correct video source has been selected, check that the Video source device is turned on and operating correctly. Also check that the signal cables have been connected correctly.
- If you have already made a Component Video connection between the projector and this S-Video source device using Component Video connections, you need not connect to this device using an S-Video connection as this makes an unnecessary second connection of poorer picture quality. See "[Connecting Video source devices](#)" on [page 18](#) for details.

Connecting a composite Video source device

Examine your Video source device to determine if it has a set of unused composite Video output sockets available:

- If so, you can continue with this procedure.
- If not, you will need to reassess which method you can use to connect to the device.

To connect the projector to an composite Video source device

1. Take an appropriate Video cable (not supplied) and connect one end to the composite Video output socket of the Video source device.
2. Connect the other end of the Video cable to the VIDEO socket on the projector.

The final connection path should be like that shown in the following diagram:

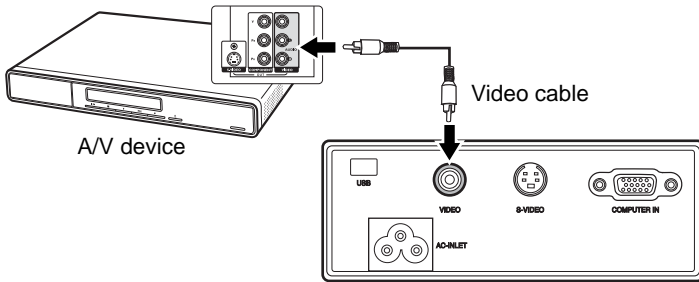

- ☞ • If the selected video image is not displayed after the projector is turned on and the correct video source has been selected, check that the Video source device is turned on and operating correctly. Also check that the signal cables have been connected correctly.
- You need only connect to this device using a composite Video connection if Component Video and S-Video inputs are unavailable for use. See "[Connecting Video source devices](#)" on [page 18](#) for details.

Basic Operation

Start up

1. Plug the power cord into the projector and into a wall socket. Turn on the wall socket switch (where fitted). Check that the **POWER** indicator on the projector lights orange after power has been applied.

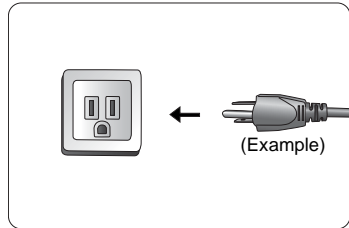
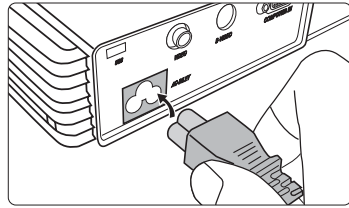

2. Slide open the lens cover. If it is left closed, it could become deformed due to heat.

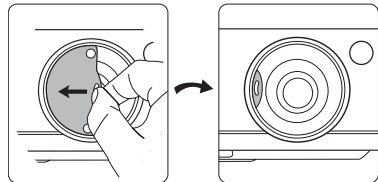

3. Press the **Power** button on the remote control or projector to start the unit. The **POWER** indicator light flashes green and stays green when the unit is on.
The start up procedure takes about 30 seconds after pressing the **Power** button. In the later stage of start up, a default XD90U logo is projected.

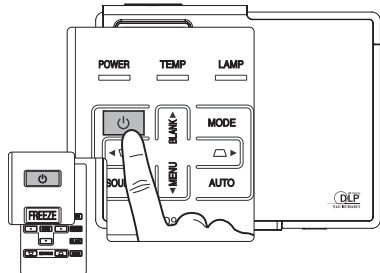

 If the projector is still hot from previous activity, it will run the cooling fan for approximately 90 seconds before energizing the lamp.

4. If you are prompted for a password, press the arrow buttons to select the four password digits, then press the **AUTO** button. For information about the password function, refer to ["Utilizing the password function"](#) on page 23.
5. Switch all of the connected equipment on.
6. The current input source being scanned displays in the upper part of a dialog on the screen. The scan will continue until signal from the input source is detected.

 If the Auto Off function (See ["Auto Off \(Off\)"](#) on page 36 for details) is activated, the projector will turn off automatically if no input signal is detected from the selected source after the period of time as set by the Auto Off function.

You can also press the **SOURCE** button to select your desired input signal manually. For more information, please refer to "Switching input signal" on page 27.

- ☞ **If the frequency/ resolution of the input signal exceeds the projector's operating range, you will see the message "Out of Range" displayed on a blank screen. This message will remain on-screen until you change the input signal to an appropriate source.**

Utilizing the password function

For security purposes and to help prevent unauthorized use, the projector includes an option for setting up password security. The password can be set through the on-screen menu. For details of the on-screen menu operation, please refer to "Using the menus" on page 30 for information.

- ☞ **WARNING: You will be inconvenienced if you activate the password functionality and subsequently forget the password. Print out this manual and write the password you used in this manual, and keep the manual in a safe place for later recall.**

To set a password

- ☞ **CAUTION: Once a password has been set, the projector cannot be used unless the correct password is entered every time the projector is started.**

1. Open the on-screen menu and go to  **Setting > Password**. Select **On** by pressing the **◀ Left** or **▶ Right** button.

2. When the function is activated for the first time, a prompt will display on the screen. Use the **▲ Up** or **▼ Down** button to select a number for each digit of the password. Use the **◀ Left** or **▶ Right** button to move between the digits of the password.

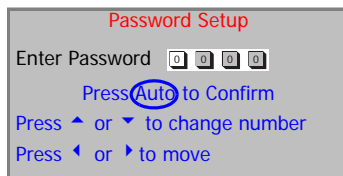

3. When all digits are entered and the password is ready, press the **AUTO** button to confirm. A confirmation message displays.

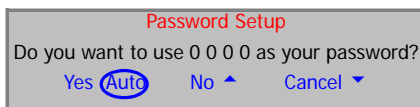

- ☞ **The password will display on-screen when being input.**
- **IMPORTANT: Write your selected password down here in this manual so that it is available to you should you ever forget it.**

Password: _ _ _ _

Keep this manual in a safe place.

4. You have the following options:
 - Press **AUTO** to continue. The set-up is finished when the message "Password setup completed" displays.
 - Press the **▲ Up** button to go back to the previous screen and re-enter four digits.
 - Press the **▼ Down** button to cancel the password set-up and return to the on-screen menu.

If you forget the password

Once activated, you will be asked to enter the four-digit password every time you turn on the projector. If you enter the wrong password, the password error message displays. You can retry by turning off the projector (by pressing the **Power** button) and start again, or if

you did not record the password in this manual, and you absolutely do not remember it, you can use the password recall procedure.

To enter the password recall procedure

Press and hold the **Right** button for 5 seconds. The projector will display a coded number on the screen. Seek help from the local service center to decode the number. You may be required to provide proof of purchase documentation to verify that you are an authorized user of the projector.

To change the password

1. Open the on-screen menu and go to  **Setting > Change Password**.
2. Press the **Left** or **Right** button. A “Change Password” message displays.
3. Enter the old password.
 - If the password is correct, you can go on to enter new password.

 **IMPORTANT:** Write your selected password down here in this manual so that it is available to you should you ever forget it.

Password: _ _ _ _ _

Keep this manual in a safe place.

- If the password is incorrect, a “Password Error” message displays. Press the **Up** button to try again or press the **Down** button to cancel.
4. Check the new password.
 5. You have the following options:
 - Press the **AUTO** button to complete the procedure.
 - Press the **Up** button to try again.
 - Press the **Down** button to cancel the set-up and return to the on-screen menu.

Adjusting the height

The projector is equipped with one quick-release adjuster foot and one rear adjuster foot. These adjusters change the image height and projection angle. To adjust the projector:

1. Lift the projector up and press the adjuster button to release the adjuster. The adjuster will drop into position and be locked.

 **Do not look into the lens while the lamp is on. The strong light from the lamp may cause damage to your eyes.**

2. Screw the rear adjuster foot to fine tune the horizontal angle.

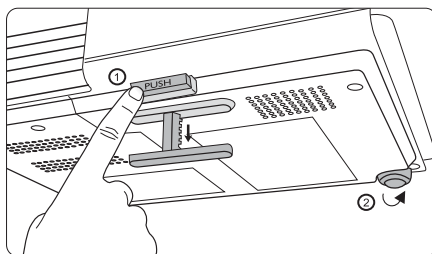

To retract the foot, hold up the projector while pressing the front adjuster button, then slowly lower the projector. Screw the rear adjuster foot in a reverse direction.

 **If the screen and the projector are not perpendicular to each other, the projected image becomes vertically trapezoidal. To correct this situation, adjust the value of Keystone in the Picture menu, on the projector control panel, or on the remote control.**

Auto-adjusting the image

In some cases, you may need to optimize the picture quality.

To do this, press the **AUTO** button. Within 3 seconds, the built-in Intelligent Auto Adjustment function will re-adjust the values of Frequency and Clock to provide the best picture quality.

The current source information will be displayed at the bottom right of the screen for 3 seconds.

 **The screen will be blank while Auto is functioning.**

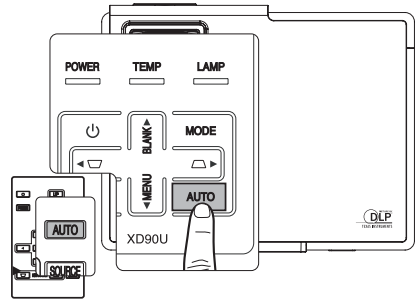

Fine-tuning the image size and clarity

1. Adjust the projected image to the size that you need using the zoom ring.
2. Then sharpen the image by rotating the focus ring.

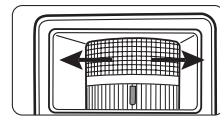
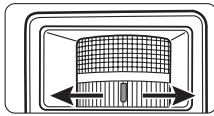





Refer to the screen size tables in "[Obtaining a preferred projected image size](#)" on page 13.

Correcting keystone

Keystoning refers to the situation where the projected image is noticeably wider at either the top or bottom. It occurs when the projector is not perpendicular to the screen.

Manual keystone correction

To correct keystoning manually, you can perform the following steps.



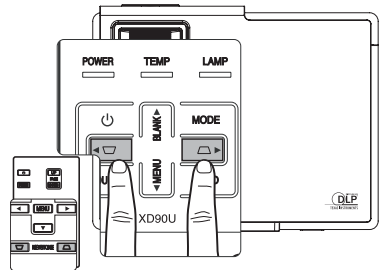





1. Adjust the projection angle of the projector.
2. Press the **AUTO** button.
3. If the image is still distorted, you will need to manually correct it following ONE of these steps.
 - Press the **Keystone**  /  **Left** or **Keystone**  /  **Right** buttons on the control panel of the projector to display the status bar labelled Keystone. Press the



Keystone ▽ / ◀ **Left** button to correct keystoneing at the top of the image. Press the **Keystone** ▽ / ▶ **Right** button to correct keystoneing at the bottom of the image.

- Press the ▽ / ▽ buttons on the remote control to display the status bar labelled Keystone, then press the ▽ button to correct keystoneing at the top of the image or press the ▽ button to correct keystoneing at the bottom of the image.
- Press the **MENU** / ▼ **Down** button on the projector or the **MENU** button on the remote control. Go to  **Picture** --> **Keystone** and adjust the values by pressing the **Keystone** ▽ / ◀ **Left** or **Keystone** ▽ / ▶ **Right** buttons on the projector, or the ◀ **Left** or ▶ **Right** buttons on the remote control.

For example,

	<ol style="list-style-type: none"> 1. Press the Keystone ▽ / ◀ Left button on the projector or 2. Press the ▽ button on the remote control or 3. Press the Keystone ▽ / ◀ Left button on the projector, or the ◀ Left button on the remote control when you are in the Picture --> Keystone menu. 	
Keystone  0		Keystone  -6
	<ol style="list-style-type: none"> 1. Press the Keystone ▽ / ▶ Right button on the projector or 2. Press the ▽ button on the remote control or 3. Press the Keystone ▽ / ▶ Right button on the projector, or the ▶ Right button on the remote control when you are in the Picture --> Keystone menu. 	
Keystone  0		Keystone  +6

Automatic keystone correction

Your projector is equipped with Autokeystone function that corrects keystoneing automatically. See "[Autokeystone \(On\)](#)" on page 31 for details.

Selecting an application mode

The projector is preset with several predefined application modes so that you can choose one to suit your operating environment and input source picture type. To select a operation mode that suits your need, press the **MODE** button. The application modes available for different types of signals are shown below. See "[Application Mode](#)" on page 31 for details.

PC Signal Input				
Brightest	Presentation (default)	Photo	Gaming	Video
YPbPr / S-Video / Video Signal Input				
Movie (default)		Cinema	Photo	Gaming

Switching input signal

The projector can be connected to multiple devices at the same time. However, it can only display one at a time. To cycle through the available input sources, press the **SOURCE** button. A source selection menu will display at the center of the screen after you press the button.

 The brightness level of the projected image will change accordingly when you switch between different input signals. Data (graphic) "PC" presentations using mostly static images are generally brighter than "Video" using mostly moving images (movies).

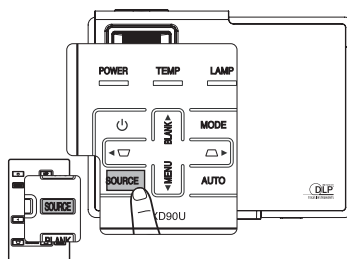



The input type affects the options available for the Application Mode. See "[Selecting an application mode](#)" on page 26 for details.

Hiding the image

In order to draw the audience's full attention to the presenter, you can press the **BLANK** (or **BLANK / ▲ Up**) button to hide the screen image. Press the button again to restore the image. The word "**BLANK**" appears at the bottom right corner of the screen while the image is hidden.

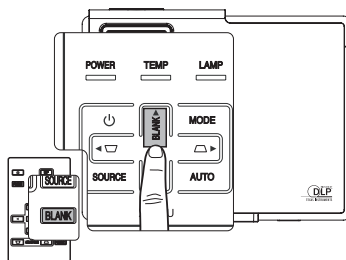
You can set the blank time in the  **Advance -> Blank Time** menu to let the projector return the image automatically after a period of time when there is no action taken on the blank screen.



 **Do not block the projection lens from projecting as this could cause the blocking object to become heated and deformed or even cause a fire.**

Remote paging operations

You can operate your display software program (on a connected PC) which responds to page up/down commands (like Microsoft PowerPoint) by pressing Page Up and Page Down on the remote control. See "[Connecting a computer](#)" on page 17 for details.

 **Connect the projector to your PC or notebook with a USB cable prior to using this function.**

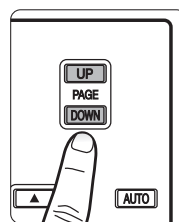

Freezing the image

Press the **Freeze** button on the remote control to freeze the image.

An icon  will display in the lower right corner of the screen. To release the function, press the **Freeze** button on the remote control, or the **SOURCE** button.

This does not remotely control the signal source. It just freezes the currently projected image.

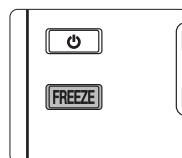

Shutdown

1. Press the **Power** button and a prompt message appears. Press the **Power** button a second time to turn the projector off.
2. The **POWER** indicator light flashes orange and the lamp shuts down, the fans continue to run for the time duration as determined by the Quick Cooling function (see "[Quick Cooling \(On\)](#)" on page 34) to cool down the projector.



To protect the lamp, the projector will not respond to any commands during the cooling process.

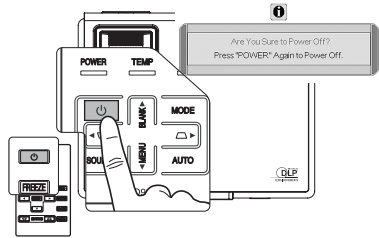

3. Disconnect the power cord from the wall socket.

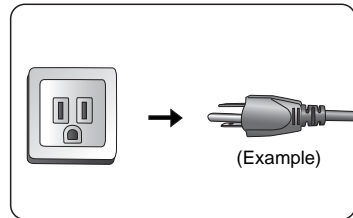





Do not unplug the power cord before the projector shutdown sequence is complete or during the cooling down process.

If the projector is not properly shut-down, you risk damaging the lamp. Do not move the projector whilst the lamp is hot.

Menu Operation

Menu system

Please note that the on-screen display (OSD) menus vary according to the signal type selected.

Functions available when receiving different signal types...		
Sub-Menu	PC	Video / S-Video / Component Video
 Picture	Application Mode Autokeystone Keystone Color Temp Brightness Contrast	Application Mode Autokeystone Keystone Color Temp Brightness Contrast Color *Tint
 Pro-Picture	Auto Resize Aspect Ratio H Position V Position Phase H. Size	Auto Resize Aspect Ratio Sharpness
 Setting	OSD Time Quick Cooling Password Change Password Reset	
 Advance	Mirror Blank Time Source Scan Language Splash Screen High Altitude Mode Auto Off Economic Mode	
 Information	Source Resolution Application Mode Equivalent Lamp Hour	Source System Application Mode Equivalent Lamp Hour

*When a Video or S-Video signal is connected, the function is only available with NTSC system selected.

Using the menus

The projector is equipped with on-screen display (OSD) menus for making various adjustments and settings.

There are different menu languages. Before making adjustments, you may choose a suitable OSD language in  **Advance > Language** menu. (Refer to "4. Advance menu" on page 35 for more details.)

The following example describes the adjustment of the keystone.

1. Press the **MENU** (or **MENU / ▼**) button to turn the on-screen menu on.

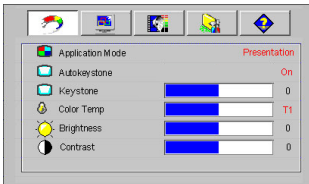

4. Adjust Keystone values by pressing the **Left ◀ / Right ▶** buttons.

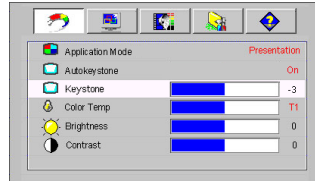

2. Use the **Left ◀ / Right ▶** buttons to select the  **Picture** menu.
3. Press the **▲ Up / ▼ Down** buttons to select **Keystone**.

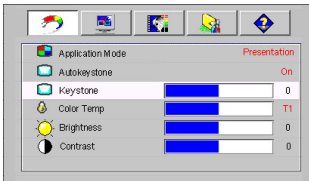





5. Press the **MENU** button to leave and save the settings. The first press leads you back to the submenu and the second press closes the on-screen menu.

1. Picture menu







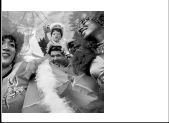
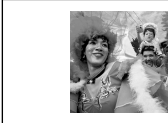

- ☞ • Some picture adjustments are available only when certain input sources are in use. Unavailable adjustments are not shown on the screen.
- Any custom selected values for **Color Temp**, **Brightness**, **Contrast**, and **Color** will be reset if you subsequently select an **Application mode** after adjusting any of their values

Function (default setting/ value)	Description
<p>Application Mode</p> <p>(PC: Presentation)</p> <p>(YPbPr/ S-Video/ Video: Movie)</p>	<p>Pre-defined application modes are provided so you can optimize your projector image set-up to suit your program type.</p> <p>☞ You can use the remote control 'Mode' button to select a predefined application mode. See "Selecting an application mode" on page 26 for details.</p> <p>PC Signal Input</p> <ol style="list-style-type: none"> 1. Brightest Mode: Maximizes the brightness of the projected image. This mode is suitable for environments where extra-high brightness is required, such as in well lit rooms. 2. Presentation Mode (Default): Is designed for presentations. The brightness is emphasized in this mode to match PC and notebook coloring. 3. Gaming Mode: Is suitable for playing PC-based games in a bright living room. 4. Photo Mode: Maximizes the purity of RGB colors to provide true-to-life images regardless of brightness setting. It is most suitable for viewing photos taken with properly calibrated camera, and for viewing PC graphic and drawing applications such as AutoCAD. 5. Video Mode: Is appropriate for playing movies, video clips from digital cameras or DVs through the PC input for best viewing in a blackened (little light) environment. <p>YPbPr/ S-Video/ Video Signal Input</p> <ol style="list-style-type: none"> 1. Photo Mode: Is perfect for viewing digital photos taken in daylight with properly calibrated camera, and for viewing Photo CDs. The color saturation and brightness are well-balanced. 2. Movie Mode (Default): Is suitable for enjoying colorful movies and TV in a home darkened (not bright) lounge room lighting level environment. 3. Cinema Mode: Is suitable for enjoying DVD movies best viewed in a blackened (little light) home cinema or lounge room environment. 4. Gaming Mode: Is suitable for playing gamebox-based video games in a normal living room lighting level environment.
<p>Autokeystone (On)</p>	<p>If this function is set to On, the projector will detect the tilt angle and correct keystoneing automatically.</p>
<p>Keystone (0)</p>	<p>Corrects any keystoneing of the image. Refer to "Correcting keystone" on page 25 for more information.</p>





<p>Color Temp (depends on the selected Application mode)</p>	<p>There are 4 color temperature* settings available.</p> <p> This value will be reset if you subsequently select an Application mode</p> <ol style="list-style-type: none"> T1: With the highest color temperature, T1 makes the image appear the most bluish white than other settings. T2: Makes images appear bluish white. T3: Maintains normal colorings for white. T4: Makes images appear reddish white. <p>*About color temperatures:</p> <p>There are many different shades that are considered to be “white” for various purposes. One of the common methods of representing white color is known as the “color temperature”. A white color with a low color temperature appears to be reddish white. A white color with a high color temperature appears to have more blue in it.</p>
<p>Brightness (depends on the selected Application mode)</p>	<p>Adjusts the brightness of the image. The higher the value, the brighter the image. And lower the value, the darker the image. Adjust this control so the black areas of the image appear as black and that detail in the dark areas is visible.</p> <div style="text-align: center;">  <p style="text-align: center;">-30 50 +70</p> </div>
<p>Contrast (depends on the selected Application mode)</p>	<p>Adjusts the degree of difference between dark and light in the image. The higher the value, the greater the contrast. Use this to set the peak white level after you have previously adjusted the Brightness setting to suit your selected input and viewing environment.</p> <div style="text-align: center;">  <p style="text-align: center;">-30 50 +70</p> </div>
<p>Color (depends on the selected input source)</p>	<p>Increases or decreases the color intensity of the image.</p>
<p>Tint (50)</p>	<p>Adjusts the color tones of the image. The higher the value, the more greenish the image becomes. The lower the value, the more reddish the image becomes.</p> <p> When a Video or S-Video signal is connected, the function is only available with NTSC system selected.</p>

2. Pro-Picture menu

 Some picture adjustments are available only when certain input ports are in use. Unavailable adjustments are not shown on the screen.

Function (default setting/ value)	Description
Auto Resize (On)	<p>Automatically resizes the input signal pixel resolution to the native resolution of the projector.</p> <p>On: The pixel resolution of the input signal is converted to the native resolution of the projector (1024 x 768). For input signals with lower resolutions, gaps in the pixels are automatically interpolated into the image before being projected. This may distort the image clarity.</p> <p>Off: The image is projected as its original resolution, with no pixel conversion. For input signals with lower resolutions, the projected image will display smaller than if resized to full screen. You could adjust the zoom setting or move the projector away from the screen to increase the image size if necessary. You may also need to refocus the projector after making these adjustments.</p>
Aspect Ratio (4:3)	<p>There are two aspect ratio settings.</p> <ul style="list-style-type: none"> • 4 : 3 (for a standard screen) • 16 : 9 (for a wide screen) <p> 16:9 aspect ratio is only sourced through the Component Video input when being fed an appropriate 16:9 aspect signal. See "Connecting a Component Video source device" on page 19 and "Obtaining a preferred projected image size" on page 13 for details.</p>
H Position (0)	<p>Adjusts the horizontal position of the projected image.</p> <div style="display: flex; justify-content: space-around; align-items: center;">   </div> <div style="display: flex; justify-content: space-around; align-items: center;"> <div style="text-align: center;">  -30 </div> <div style="text-align: center;">  +30 </div> </div>
V Position (0)	<p>Adjusts the vertical position of the projected image.</p> <div style="display: flex; justify-content: space-around; align-items: center;">   </div> <div style="display: flex; justify-content: space-around; align-items: center;"> <div style="text-align: center;">  -30 </div> <div style="text-align: center;">  +30 </div> </div>
Phase (depends on the selected input source)	<p>This function allows you to adjust the clock phase to reduce image distortion.</p> 
H Size (0)	Adjusts the horizontal width of the image.
Sharpness (15)	Adjusts the image to make it look sharper or softer.

3. Setting menu

Function (default setting/ value)	Description
OSD Time (10)	Sets the length of time the OSD will remain active after your last button press. The range is from 5 to 100 seconds.
Quick Cooling (On)	Enables or disables the Quick Cooling function. Selecting On enables the function and projector cooling time will be shortened from a normal 90-second duration to approximately 30 seconds.
Password (off)	<p>This is a selectable function. Selecting On limits use of the projector to only those who know the correct password. When the function is activated for the first time, you have to set a password for it. For more information, refer to "Utilizing the password function" on page 23. Once the password is set and this function is selected, the projector is password-protected. Users who do not know the correct password can not use the projector.</p> <p> WARNING: You will be inconvenienced if you activate the password functionality and subsequently forget the password. If viewing online, print out this manual and write the password you used in this manual, and keep it in a safe place for later recall.</p> <p>The password can be entered by using either the buttons on the projector or the remote control.</p> <p> The password will display on-screen when being input.</p>
Change Password	<p>You will be asked to enter the current password before changing to a new one. For more information, refer to "Utilizing the password function" on page 23.</p> <p> This function does not work before password setting.</p>
Reset	<p>Returns all settings to the factory preset values.</p> <p> The following settings will still remain: Mirror, Language and Password.</p>

4. Advance menu

Function (default setting/ value)	Description
Mirror (Floor front)	The projector can be installed behind a screen. In such case, you can use this function to set the correct orientation of the projected image. Refer to " Choosing a location " on page 13 for more information.
Blank Time (20)	Sets the image blank time when the Blank feature is activated, once elapsed, the image will return to the screen.
Source Scan (On)	Sets whether the projector searches automatically for input signals. If the source scan is On, the projector will scan for input signals until it acquires a signal. If the function is not activated, the projector selects the last used input signal.
Language (English)	<p>Language sets the language for the OSD control menus. The available languages are: English, French, German, Spanish, Italian, Russian, Swedish, Dutch, Polish, Czech, Simplified Chinese, Traditional Chinese, Japanese, Korean, Thai, Portuguese and Turkish.</p> <p>Use the Keystone ▽ / ◀ Left or Keystone △ / ▶ Right buttons on the projector, or the ◀ Left or ▶ Right buttons on the remote control to select your desired language.</p>
Splash Screen (XD90U logo)	Allows you to select which logo screen will display during projector start-up. Three modes are available: Default, black screen or blue screen.
High Altitude Mode (Off)	<p>A mode for operations in areas like high altitude or high temperature. We recommend you use the High Altitude Mode when your environment is higher than 3000 feet above sea level, or is hotter than 40°C.</p> <p>To activate the High Altitude Mode, select On by pressing Left ◀ / Right ▶ on the projector or remote control. A confirmation message displays. Press AUTO.</p> <div data-bbox="381 1002 1001 1177" data-label="Image"> </div> <p>Next time you turn on the projector, it will show a message pictured below as a reminder during the start-up.</p> <div data-bbox="381 1246 1001 1369" data-label="Image"> </div> <p>Operation under "High Altitude Mode" may cause a higher decibel operating noise level because of increased fan speed necessary to improve overall system cooling and performance.</p>

<p>High Altitude Mode (Off)</p>	<p>If you use this projector under other extreme conditions excluding the above, it may display auto shut-down symptoms, which is designed to protect your projector from over-heating. In cases like this, you should switch to High Altitude mode to solve these symptoms. However, this is not to state that this projector can operate under any and all harsh or extreme conditions, or whenever the projector will be used for extended periods of time (>10hours) without shutdown.</p>
<p>Auto Off (Off)</p>	<p>This function allows the projector to turn off automatically if no input signal is detected after a set period of time. Press Left ◀ / Right ▶ on the projector or remote control to set the duration before the projector is turned off. Selecting Off disables this function.</p>
<p>Economic Mode (Off)</p>	<p>Use this mode to reduce system noise and reduce power consumption by 20%. If this mode is activated, the light output will be reduced and result in darker projected images.</p> <p> Setting the projector in Economic mode extends the lamp timer automatic shutdown feature. For more information on how the total lamp hour is calculated, see "Calculation of lamp hour" on page 39.</p>

5. Information Menu

This menu shows you the current operating status of the projector.

 Some picture adjustments are available only when certain input ports are in use. Unavailable adjustments are not shown on the screen.

Function	Description
Source	Shows the current signal source.
Resolution	Shows the native resolution of the input signal.
Application Mode	Shows the selected application mode in the  Picture menu.
Equivalent Lamp Hour	Displays the number of hours the lamp has been used.
System	Shows the Video input system format, NTSC, SECAM or PAL.

Maintenance

Care of the projector

Your projector needs little maintenance. The only thing you need to do on a regular basis is to keep the lens clean.

Never remove any parts of the projector except the lamp. Contact your dealer if other parts need replacing.

Cleaning the lens

Clean the lens whenever you notice dirt or dust on the surface.

- Use a canister of compressed air to remove dust.
- If there is dirt or smears, use lens-cleaning paper or moisten a soft cloth with lens cleaner and gently wipe the lens surface.

 **Never rub the lens with abrasive materials.**

Cleaning the projector case

Before you clean the case, turn the projector off using the proper shutdown procedure as described in "[Shutdown](#)" on page 28 and unplug the power cord.

- To remove dirt or dust, wipe the case with a soft, dry, lint-free cloth.
- To remove stubborn dirt or stains, moisten a soft cloth with water and a neutral pH detergent. Then wipe the case.

 **Never use wax, alcohol, benzene, thinner or other chemical detergents. These can damage the case.**

- **Do not use flammable solvents (benzene, thinner, etc.) and flammable aerosols when cleaning the projector body and lens. Flammable substances may ignite causing fire or breakdown while the lamp is illuminating.**

Storing the projector

If you need to store the projector for an extended time, please follow the instructions below:

- Make sure the temperature and humidity of the storage area are within the recommended range for the projector. Please refer to "[Specifications](#)" on page 46 or consult your dealer about the range.
- Retract the adjuster feet.
- Remove the battery from the remote control.
- Pack the projector in its original packing or equivalent.

Transporting the projector

It is recommended that you ship the projector with its original packing or equivalent. When you carry the projector yourself, please use the original box or provided soft carry case.

Calculation of lamp hour

When the projector is in operation, the duration (by hours) of lamp usage is automatically calculated by the built-in timer. The method of calculating the equivalent lamp hour is as follows:

Total (equivalent) lamp hour = hours used in Economic mode + hours used in normal mode

☞ See "**Economic Mode (Off)**" on page 36 for more information on Economic mode.

The lamp hour in Economic mode is calculated as 2/3 of that in normal mode. That is, using the projector in Economic mode helps to extend the lamp hour by 1/3.





Warning message

When the **LAMP indicator** lights up red or a message appears suggesting it is time to replace the lamp, please install a new lamp or consult your dealer. An old lamp may cause a malfunction in the projector and in some instances the lamp may explode.

For more detailed information on projector warnings, please refer to "**Illustration**" on page 42.

⚠ **The LAMP indicator light and TEMP (Temperature) warning light will light up if the lamp becomes too hot. Turn the power off and let the projector cool for 45 minutes. If the LAMP or TEMP indicator still lights up after turning the power back on, please contact your dealer.**

The following Lamp warning displays will remind you to change the lamp.

Message	Status
 <p>Lamp Warning Lamp > 1800 Hours The Power will Turn Off After 2000 Hours</p>	The lamp has been in operation for 1800 hours. Install a new lamp for optimal performance. You may continue to operate the projector until the 1950 hour lamp warning appears.
 <p>Change The Lamp! Lamp > 1950 Hours The Power will Turn Off After 2000 Hours</p>	The lamp has been in operation for 1950 hours. A new lamp should be fitted to avoid the inconvenience when the projector runs out of lamp time.
 <p>Change The Lamp! Lamp > 2000 Hours Out Of Lamp Usage time</p>	The lamp has been in operation for over 2000 hours. This message will show up in the center of the screen for about 45 seconds together with the LAMP indicator lighting up red for 40 seconds.
 <p>Out Of Lamp Usage Time Power Off Automatically To Protect Your Projector Change the Lamp And Reset The Lamp Timer</p>	If this warning message displays, the projector will shutdown in 40 seconds. The lamp MUST be replaced before the projector will operate normally.

Replacing the Lamp



- To reduce the risk of electrical shock, always turn the projector off and disconnect the power cord before changing the lamp.
- To reduce the risk of severe burns, allow the projector to cool for at least 45 minutes before replacing the lamp.
- To reduce the risk of injuries to fingers and damage to internal components, use caution when removing lamp glass that has shattered into sharp pieces.
- To reduce the risk of injuries to fingers and/or compromising image quality by touching the lens, do not touch the empty lamp compartment when the lamp is removed.
- This projector uses a lamp that contains mercury. Disposal of the lamp or the projector with the lamp may be regulated due to environmental considerations. For disposal or recycling information, please contact your local authorities or the Electronic Industries Alliance: www.eiae.org. (For US only).
- If the lamp should break, small glass fragments may fall out through the grilles and some may remain inside of the projector or the lamp box. When taking the lamp box out, be sure to turn over the projector and hold the handle of the lamp box to avoid injury due to the glass fragments.
- If the lamp should break, never shake the lamp box or hold it in front of your face after removing it. The glass fragments may fall out and cause injury to your eyes.

Step 1. Turn the power off and disconnect the projector from the wall socket.

Step 2. Protect the projector's surface by clearing a flat open area on your desk and placing a soft item on the desk for padding.

Step 3. Turn the projector over. Then loosen the screws.

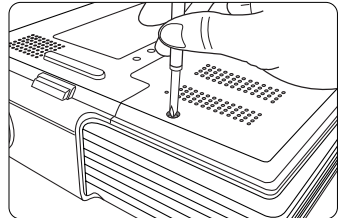

Step 4. Remove the lamp cover. If the lamp is hot, avoid burns by waiting for 45 minutes until the lamp has cooled.

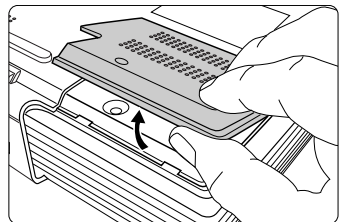

Step 5. Loosen the screw fixing the lamp to the projector. If the screw is not loosened completely, the lamp cannot be removed. Be careful not to lose the screw as it is needed to hold the replacement lamp in place. It is strongly recommended that you use a magnetic-head screwdriver.

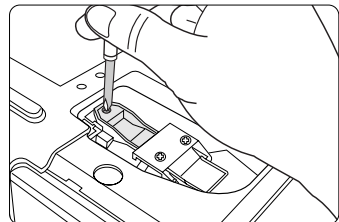

Step 6. Lift the handle so that it stands up. Use the handle to slowly pull the lamp out of the projector.

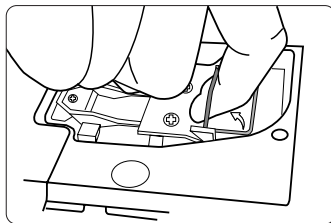

- ☞ • Pulling it too quickly may cause the lamp to break and scatter broken glass in the projector.
- Do not place the lamp in locations where water might splash on it, children can reach it, or near flammable materials.
- Do not insert your hands into the projector after the lamp is removed. If you touch the optical components inside, it could cause color unevenness and distortion of the projected images.

Step 7. Insert a new lamp. Ensure the handle is fully laid flat and locked in place. Reinsert and tighten the screw firmly.

- ☞ • Loose screw may cause a bad connection, which could result in malfunction.
- Do not over tighten the screw.

Step 8. Reinstall the lamp cover and tighten the screws.

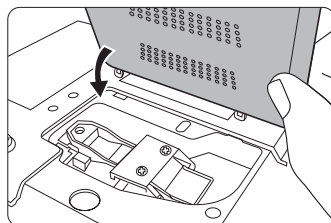

Step 9. Restart the projector.

- ☞ • Do not turn the power on with the lamp cover removed.

Step 10. Resetting the lamp counter.

- ☞ • Do not reset if the lamp is not replaced as this could cause damage.
 - i. Press and hold the **BLANK / ^ Up** button on the projector for 5 seconds to display the total used lamp time.
 - ii. Press the **AUTO** button to reset the lamp hour to "0".
 - iii. Wait about 5 seconds to let the OSD disappear.

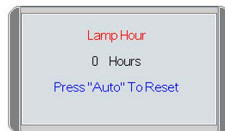

Temperature information



When the **TEMPerature** warning light flashes, it is warning you of the following possible problems:













- The internal temperature is too high.
- The fans are not working.

Turn the projector off and contact qualified service personnel for further help. For more detailed information, please refer to "[Illustration](#)" on page 42.

Indicators

Illustration

- Blank - : Light OFF
-  : Light flashing
-  : Light ON
- **O** : Orange light
- **R** : Red light
- **G** : Green light

Light			Status & Description
POWER	TEMPERature	LAMP	
Power events			
	-	-	<ul style="list-style-type: none"> • The projector needs to cool after the power is turned off. • The projector is in the startup cooling process.
	-	-	Stand-by mode.
	-	-	The Power indicator light is flashing during powering up.
	-	-	The projector is under normal operation.
Lamp events			
	-		The lamp is not properly attached or the lamp is damaged. Please contact your dealer for assistance.
-	-		It is warning you that lamp usage has exceeded 2000 / 3000 (Economic mode) hours. Replace the projection lamp with a new one immediately.
Thermal events			
-		-	The projector has shutdown automatically. If you try to re-start the projector, it will shutdown again. Please contact your dealer for assistance.
-			
-			

Thermal events			
-	R	O	The projector has shutdown automatically. If you try to re-start the projector, it will shutdown again. Please contact your dealer for assistance.
R	R	R	
R	R	G	
R	R	O	
G	R	R	
G	R	G	
G	R	O	
O	R	R	
O	R	G	
O	R	O	
-	G	R	
-	G	G	

Troubleshooting

⑦ The projector does not turn on.

Cause	Remedy
There is no power from the power cable.	Plug the power cord into the AC inlet on the projector, and plug the power cord into the power outlet. If the power outlet has a switch, make sure that it is switched on. See "Start up" on page 22 for details.
Attempting to turn the projector on again during the cooling process.	Wait until the cooling down process has completed. See "Shutdown" on page 28 for details.

⑦ No picture.

Cause	Remedy
The video source is not turned on or connected correctly.	Turn the video source on and check that the signal cable is connected correctly. See "Basic Connection" on page 17 for details.
The projector is not correctly connected to the input source device.	Check the connection. See "Basic Connection" on page 17 for details.
The input signal has not been correctly selected.	Select the correct input signal with the SOURCE button on the projector or remote control. See "Switching input signal" on page 27 for details.
The lens cover is not open.	Slide open the lens cover.

⑦ Image is unstable.

Cause	Remedy
The connection cables are not securely connected to the projector or the signal source.	Correctly connect the cables to the appropriate terminals. See "Basic Connection" on page 17 for details.

⑦ Image is blurred.

Cause	Remedy
The projection lens is not correctly focused.	Adjust the focus of the lens using the focus ring. See "Fine-tuning the image size and clarity" on page 25 for details.
The projector and the screen are not aligned properly.	Adjust the projection angle and direction as well as the height of the unit if necessary. See "Obtaining a preferred projected image size" on page 13 for details.
The lens cover is not open.	Slide open the lens cover.

⑦ **Remote control does not work.**

Cause	Remedy
The battery is out of power.	Replace the battery with a new one.
There is an obstacle between the remote control and the projector.	Remove the obstacle.
You are too far away from the projector.	Stand within 6 meters (~ 20 feet) of the projector.

⑦ **Color tint.**

Cause	Remedy
Different color tint.	When comparing images projected by two projectors, tints in the displayed images may be different because of variation between their optical components. This is not a malfunction.
	When comparing the image projected by this projector with those displayed on the television or PC monitor, tints in the displayed images may be different because of difference in the range of color reproducibility. This is not a malfunction.

Specifications

Projector specifications

 All specifications are subject to change without notice.

General

Product name	Digital Projector
Model name	XD90U

Optical

Resolution	1024 x 768 XGA
Display system	1-CHIP DMD
Lens F/Number	F=2.6 to 2.96, f= 25.8 to 30 mm
Lamp	132W lamp

Electrical

Power supply	AC100 - 240V, 2.2A, 50/60 Hz (Automatic)
Power consumption	190W (Max)

Mechanical

Dimensions	218 mm (W) x 67 mm (H) x 167 mm (D)
Weight	2.9 lb (1.3 Kg)

Input terminal

Computer input	
RGB input	D-sub 15-pin (female) x 1
Video signal input	
S-VIDEO	Mini DIN 4-pin port x 1
VIDEO	RCA x 1
HDTV signal input	D-sub <--> Component RCA jack x 3, through RGB input

Output

USB mouse connector	Mini B type x 1
---------------------	-----------------

Environmental requirements

Operating temperature	0°C - 40°C at sea level
Operating relative humidity	10% - 90% (without condensation)
Operating altitude	<ul style="list-style-type: none">• 0 - 3000 feet at 0°C - 40°C• 3000 - 6000 feet at 0°C - 30°C• 6000 - 10000 feet at 0°C - 23°C

Dimensions

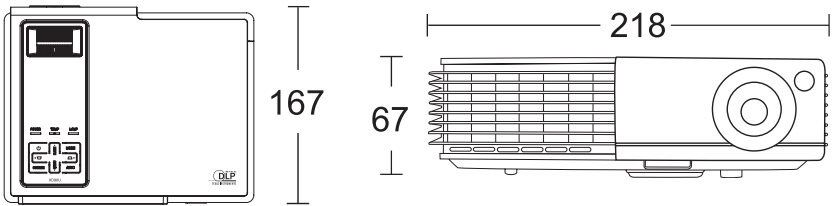

Unit: mm

Timing chart

Supported timing for PC input

Resolution	Horizontal Frequency (kHz)	Vertical Frequency (Hz)	Pixel Frequency (MHz)
640 x 480	31.469	59.940	25.175
	35.000	66.667	30.240
	37.861	72.809	31.500
	37.500	75.000	31.500
	43.269	85.008	36.000
800 x 600	37.879	60.317	40.000
	48.077	72.188	50.000
	46.875	75.000	49.500
	53.674	85.061	56.250
832 x 624	49.722	74.546	57.280
1024 x 768 (native)	48.363	60.004	65.000
	56.476	70.069	75.000
	60.241	75.020	80.000
	60.023	75.029	78.750
	68.667	84.997	94.500
1280 x 1024	63.981	60.020	108.000
1400 x 1050	63.973	60.012	118.094

 To achieve the best quality projected image, please use the projector's native resolution of 1024 x 768.

What's included in the box

AC power cord	for US 2G.01112.001	1 Remote control
	for EU 2G.00922.001	1 Safety manual/Quick start up
	for UK 2G.03132.001	1 CD-ROM
1 RGB cable	5K.J0V05.501	1 Battery
1 USB cable	5K.J1B01.501	1 Soft carry case

Replacement part

(Option / Not included in the box)

Spare lamp: VLT-XD90LP

Supported timing for Component-YP_bP_r Input

Signal Format	Horizontal Frequency (kHz)	Vertical Frequency (Hz)
480i(525i)@60Hz	15.73	59.94
480p(525p)@60Hz	31.47	59.94
576i(625i)@50Hz	15.63	50.00
576p(625p)@50Hz	31.25	50.00
720p(750p)@60Hz	45.00	60.00
720p(750p)@50Hz	37.50	50.00
1080i(1125i)@60Hz	33.75	60.00
1080i(1125i)@50Hz	28.13	50.00

Supported timing for Video and S-Video inputs

Video mode	Horizontal Frequency (kHz)	Vertical Frequency (Hz)	Color sub-carrier Frequency (MHz)
NTSC	15.73	60	3.58
PAL	15.63	50	4.43
SECAM	15.63	50	4.25 or 4.41
PAL-M	15.73	60	3.58
PAL-N	15.63	50	3.58
PAL-60	15.73	60	4.43
NTSC4.43	15.73	60	4.43

MITSUBISHI Projector Contact Information

North America

MESCA (Mitsubishi Electric Sales Canada Inc.)
<http://www.mitsubishielectric.ca>
Information Technologies Group, 4299 14th Avenue,
Markham, Ontario L3R 0J2, Canada
Sales & Technical Inquiries

Phone :+1-(800) 450-6487
Fax :+1-(905) 475-7958
E-mail :projectors@mitsubishielectric.ca
Customer Care
E-mail :support@mitsubishielectric.ca

MDEA (Mitsubishi Digital Electronics America, Inc.)
(Warranty Registration)
<http://www.mitsubishi-presentations.com/>
Presentation Products Division, 9351 Jeronimo Road,
Irvine, CA 92618 U.S.A

Sales & Inquiries
Phone :+1(888) 307-0349 or +1(949)465-6000
E-mail :ppdinfo@mdea.com
Technical Inquiries
Phone :+1-(888) 307-0309
E-mail :TSUPPORT@mdea.com

Europe

MEU-FRA (Mitsubishi Electric Europe B.V. French Branch)
25, Boulevard des Bouvets 92 741, Nanterre CEDEX,
France
Sales Inquiries

Phone :+33 (0)1 55-68-55-53
Fax :+33 (0)1 55-68-57-31
Technical Inquiries
Phone :+33 (0)1 55-68-56-42
Fax :+33 (0)1 55-68-57-31

MEU-GER (Mitsubishi Electric Europe B.V. German Branch)
<http://www.mitsubishi-evs.de/>
Gothaer Strasse 8, 40880 Ratingen, Germany

Sales Inquiries
Phone :0049 - 2102 - 486 9250
Fax :0049 - 2102 - 486 7320
Technical Inquiries
Phone :0049 - 2102 - 486 1330
Fax :0049 - 2102 - 486 1340

MEU-IR (Mitsubishi Electric Europe B.V. Irish Branch)
<http://www.mitsubishi.ie/>
Westgate Business Park, Ballymount, Dublin 24, Ireland

Sales Inquiries
Phone :+353-1-4198807
Fax :+353-1-4198890
Technical Inquiries
Phone :+353-1-4198808
Fax :+353-1-4198895

MEU-IT (Mitsubishi Electric Europe B.V. Italian Branch)
Centro Direzionale Colleoni, Palazzo Siro, Viale Colleoni 7,
20041 Agrate Brianza, Italy

Sales & Technical Inquiries
Phone :+39-(0)39-60531
Fax :+39-(0)39-6053214
E-mail :info.projector@it.mee.com

MEU-NL (Mitsubishi Electric Europe B.V. Benelux Branch)
<http://www.mitsubishi.nl/LCD/ProdFrame.html>
Nijverheidsweg 23A, 3641 RP Mijdrecht, The Netherlands

Sales Inquiries
Phone :+31-297-282461
Fax :+31-297-283936
E-mail :info@mitsubishi.nl
Technical Inquiries
Phone :+31-297-282461
Fax :+31-297-283936
E-mail :info@mitsubishi.nl

Russia (Mitsubishi Electric Europe B.V. Moscow
Representative Office)
<http://www.mitsubishi-projector.ru/>
Moscow Representative Office, 52/5 Kosmodamianskaya
Nab., 115054, Moscow, Russia

Sales & Technical Inquiries
Phone :+7(095) 721-2068
Fax :+7(095) 721-2071

MEU-SP (Mitsubishi Electric Europe B.V. Spanish Branch)

<http://www.mitsubishielectric.es/>
Ctra. de Rubi, 76-80, 08173 Sant Cugat del Valles,
Barcelona, Spain
Sales Inquiries
Phone :+34-93.565.31.54
Fax :+34-93.589.43.88
E-mail :mitsubishi.profesional@sp.mee.com
Technical Inquiries
Phone :+34-93.586.27.51
Fax :+34-93.588.53.87
E-mail :mitsubishi.profesional@sp.mee.com

MEU-SWE (Mitsubishi Electric Europe B.V. Scandinavian
Branch)

Hammarbacken 14, Box 750, S-19127, Sollentuna, Sweden
Sales Inquiries
Phone :+46-(0)8-6251070
Fax :+46-(0)8-6251036
Technical Inquiries
Phone :+46-(0)8-6251052
Fax :+46-(0)8-6251036

MEU-UK (Mitsubishi Electric Europe)

<http://www.mitsubishi.co.uk/evs/>
Visual Information Systems Division, Travellers Lane,
Hatfield, Hertfordshire, AL10 8XB U.K.
Sales Inquiries
Phone :+44 (1707) 278684
Fax :+44 (1707) 278541
E-mail :projector.info@meuk.mee.com
Technical Inquiries
Phone :+44 (870) 606 5008
Fax :+44 (1506) 431927
E-mail :projector.info@meuk.mee.com

Asia

CHINA (Mitsubishi Electric Air-Conditioning & Visual
Information Systems (Shanghai) Ltd.)
26/F, Oriental Center, 699 Nanjing Rd(W), Shanghai,
200041, China

Sales Inquiries
Phone :+86(21) 5211-0882-3002
Fax :+86(21) 5211-0576
Technical Inquiries
Phone :+86(21) 5211-0882-3020
Fax :+86(21) 5211-0576

HONG KONG (Mitsubishi Electric Ryoden Air-Conditioning
& Visual Information Systems (HongKong) Ltd.)

7th Floor, Manulife Tower, 169 Electric Road, North Point,
Hong Kong
Sales Inquiries
Phone :+852-2510-1505
Fax :+852-2510-0463
Technical Inquiries
Phone :+852-2422-0161
Fax :+852-2487-0181

SINGAPORE (Mitsubishi Electric Asia Pte. Ltd.)

<http://www.mitsubishielectric.com.sg>
307, Alexandra Road, #05-01/02 Mitsubishi Electric
Building, Singapore 159943

Sales Inquiries
Phone :+65-6473-2308
Fax :+65-6475-9503
E-mail :Peripherals@asia.meap.com
Technical Inquiries
Phone :+65-6470-2666
Fax :+65-6475-9503

INDIA (Mitsubishi Electric Asia Pte. Ltd.)

307, Alexandra Road, #05-01/02 Mitsubishi Electric
Building, Singapore 159943
Sales Inquiries
Phone :+65-6473-2308
Fax :+65-6475-9503
E-mail :Peripherals@asia.meap.com
Technical Inquiries
Phone :+65-6470-2666
Fax :+65-6475-9503

INDONESIA (Mitsubishi Electric Asia Pte. Ltd.)

307, Alexandra Road, #05-01/02 Mitsubishi Electric
Building, Singapore 159943
Sales Inquiries
Phone :+65-6473-2308
Fax :+65-6475-9503
E-mail :Peripherals@asia.meap.com
Technical Inquiries
Phone :+65-6470-2666
Fax :+65-6475-9503

PHILIPPINES (Mitsubishi Electric Asia Pte. Ltd.)

<http://www.mitsubishielectric.com.sg>
307, Alexandra Road, #05-01/02 Mitsubishi Electric
Building, Singapore 159943
Sales Inquiries
Phone :+65-6473-2308
Fax :+65-6475-9503
E-mail :Peripherals@asia.meap.com
Technical Inquiries
Phone :+65-6470-2666
Fax :+65-6475-9503

VIETNAM (Mitsubishi Electric Asia Pte. Ltd.)

<http://www.mitsubishielectric.com.sg>
307, Alexandra Road, #05-01/02 Mitsubishi Electric
Building, Singapore 159943
Sales Inquiries
Phone :+65-6473-2308
Fax :+65-6475-9503
E-mail :Peripherals@asia.meap.com
Technical Inquiries
Phone :+65-6470-2666
Fax :+65-6475-9503

STC (Systeco Astec Corporation Seoul Branch)
4F,Dongseo Game Channel Bldg,660-11 Deungchon-Dong,
Kangseo-Ku, Seoul, Korea

Sales & Technical Inquiries
Phone :+82-(0)2-2657-9841-3
Fax :+82-(0)2-2657-9900

MALAYSIA (Antah Matco Sales & Services Sdn. Bhd.)
6, Jalan 13/6 46860 Petaling Jaya Selangor, Darul Ehsan,
Malaysia

Sales & Technical Inquiries
Phone :+60-(0)3-79552088 (Ext. 203)
Fax :+60-(0)3-79563950/+60-(0)3-79582576
Technical & Service Inquiries
Phone :+60-(0)3-79552088 (Ext. 106)
Fax :+60-(0)3-79563950/+60-(0)3-79582576

ME-TWN (Mitsubishi Electric Taiwan Co., Ltd.)

<http://www.mitsubishielectric.com.tw>
11TH FL., 90 SEC. 6, CHUNG SHAN N. RD., TAIPEI, 111
R.O.C.
Sales & Technical Inquiries
Phone :+886-2-2832-8255
Fax :+886-2-2833-9813

MKY (Mitsubishi Electric Kang Yong Watana Co., Ltd.)

<http://www.mitsubishi-ky.co.th>
Road, Huamark Bangkok, Bangkok 10240, Thailand
Sales & Technical Inquiries
Phone :+66-2-731-6841
Fax :+66-2-379-4763

Oceania

ME-AUST (Mitsubishi Electric Australia)
<http://www.mitsubishi-electric.com.au/prod.asp?prod=proj>
348 Victoria Road, Rydalmere, N.S.W. 2116, Australia
Sales & Technical Inquiries

Phone :+61(2)9684-7777
Fax :+61(2)9684-7208
E-mail :diamonddigital@meaust.meap.com
Technical Inquiries
Phone :+61(2)9684-7694
Fax :+61(2)9684-7684
E-mail :service@meaust.meap.com

BDT (Black Diamond Technologies Ltd.)
(Warranty Registration) <http://www.bdt.co.nz/projectors/warranty.asp>
1 Parliament St, Lower Hutt, Wellington, New Zealand
Sales Inquiries

Phone :+64-(0)4-560-9100
Fax :+64-(0)4-560-9133
E-mail :projectorsales@bdt.co.nz
Technical Inquiries
Phone :+64-(0)4-560-9100
Fax :+64-(0)4-560-9133
E-mail :service@bdt.co.nz



MITSUBISHI ELECTRIC CORPORATION

1 Zusho Baba, Nagaokakyo-City, Kyoto Japan